

INSTALLATION AND OPERATING MANUAL FOR DAB DEEP WELL JET PUMPS

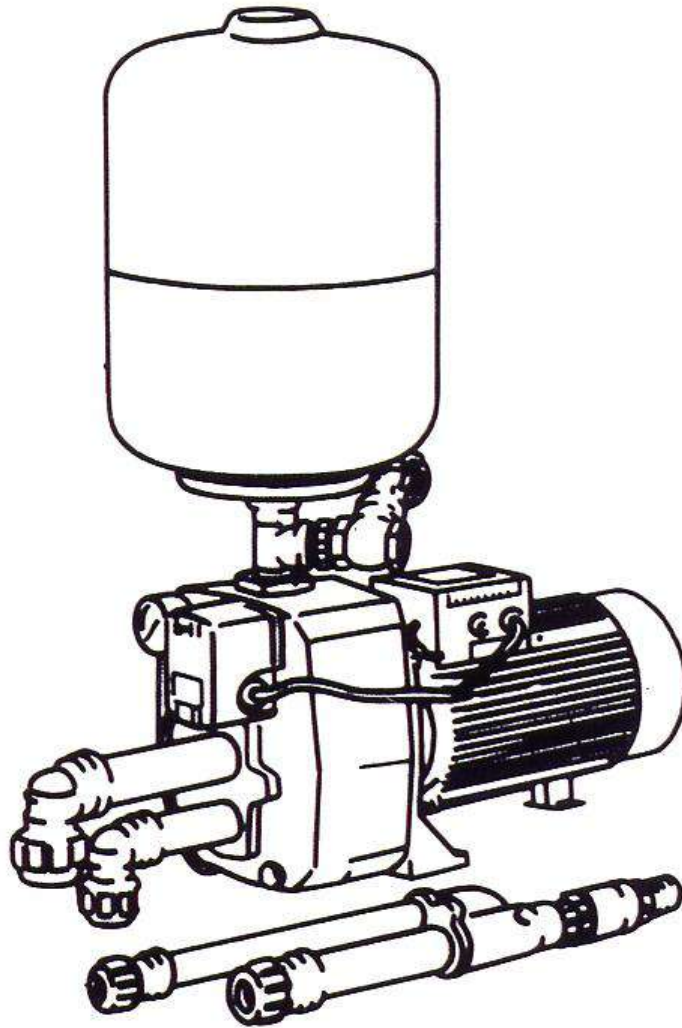

GENERAL DATA

Applications

Self-priming centrifugal pump for suction up to 27 metres, reached by means of an ejector to be inserted in wells with a diameter of 4" or over. For use in supplying water to farmhouses and in small-scale agriculture.

Constructional features of the pump

Pump: Cast iron pump body and motor support. Technopolymer impeller and diffuser. Stainless steel pressure disc. Carbon/ceramic mechanical seal.

Ejector: Cast iron body. Technopolymer A Venturi tube and brass nozzle.

The ejector is available in three models (E20 - E25 - E30) to be chosen according to performance requirements.

Constructional features of the motor

Induction motor, closed and cooled with external ventilation.

Rotor mounted on oversized greased sealed-for-life ball bearings.

Built-in thermal and current overload protection and a capacitor permanently in circuit in the single-phase version.

Three-phase motors should be protected with a suitable overload protection complying with the regulations in force.

Manufactured according to CEI 61-69 standards (EN 60335-2-41).

Motor protection: IP44

Terminal box protection: IP55

Insulation class: F

Standard voltage: single-phase 220-240 V/50 Hz three-phase 230-400 V/50 Hz

TECHNICAL DATA

- Operating range: up to 4.3 m³/h.
- Liquid quality requirements: clean, free from solids or abrasive substances, non viscous, non aggressive, non crystallized, chemically neutral, close to the characteristics of water.
- Liquid temperature range: from 0°C to +35°C for domestic use (EN 60335-2-41)
from 0°C to +40°C for other uses
- Maximum ambient temperature: +40°C
- Maximum operating pressure: DP 81 - DP 100 6 bar (600 kPa)
DP 151 - DP 251 8 bar (800 kPa)
- Installation: fixed in a horizontal position
- Special executions on request: other voltages and/or frequencies

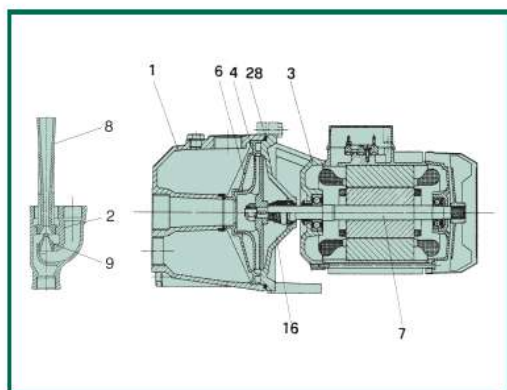

N	PARTS	MATERIALS
1	PUMP BODY	CAST IRON 200 UNI ISO 185
2	EJECTOR BODY	CAST IRON 200 UNI ISO 185
3	SUPPORT	CAST IRON 200 UNI ISO 185
4	IMPELLER	TECHNOPOLYMER
6	DIFFUSER	TECHNOPOLYMER
7	SHAFT WITH ROTOR	STAINLESS STEEL AISI 416 X12 CrS13 UNI 6900/71 (DP 80 – DP 100) STAINLESS STEEL AISI 303 X10CrNiS 1809 UNI 6900/71 (DP 151 – DP 251)
8	VENTURI	TECHNOPOLYMER
9	JET	BRASS
16	MECHANICAL SEAL	CARBON/CERAMIC/NBR
28	BODY O RING	NBR RUBBER

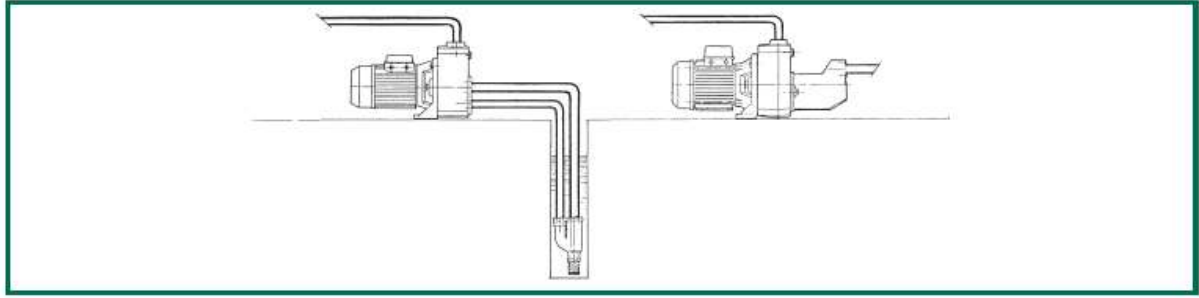

DEEP WELL AND SHALLOW WELL CONVERTABLE 151 - 251

DP 81 – DP 100

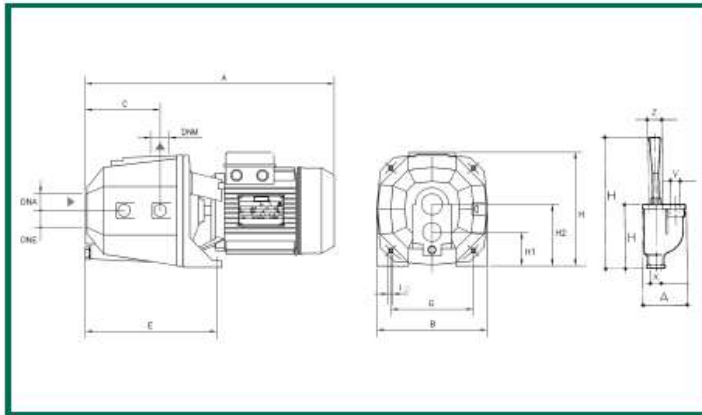

HYDRAULIC DATA (n = 2800 1/min)							
PUMP TYPE	EJECTOR TYPE	SUCTION DEPTH	Delivery pressure in bar				
			1,5	2	2,5	3	3,5
DP 81	E 25	9	2140	1410	730	-	-
		12	1730	1000	400	-	-
		15	1220	580	-	-	-
	E 30	9	1790	1340	950	620	360
		12	1500	1100	740	460	250
		15	1260	880	570	320	-
DP 100	E 25	9	2580	1870	1120	470	-
		12	1990	1400	720	-	-
		15	1400	950	380	-	-
	E 30	12	1770	1350	980	650	400
		15	1500	1120	775	500	280
		18	1260	910	600	350	150
		21	-	720	450	250	-

MODEL	A	B	C	E	G	I Ø	H	H1	H2	DNA	DNM	DNE	EIETTORE						PACKING DIMENSIONS			VOL. m³	WEIGHT Kg
													A	H	H1	x	y	z	L/A	L/B	H		
DP 81	365	180	90	202	140	9,5	225	47	92	1 1/4" G	1" G	1" G	97	295	143	1" G	1" G	1 1/4" G	452	218	257	0,025	13
DP 100	385	180	90	202	140	9,5	225	47	92	1 1/4" G	1" G	1" G	97	295	143	1" G	1" G	1 1/4" G	492	224	277	0,030	15,7

MODEL	ELECTRICAL DATA						
	VOLTAGE 50 Hz	P1 MAX kW	P2 NOMINAL		In A	CAPACITOR	
			kW	HP		µF	Vc
DP 81 M	1x220-240 V -	0,69	0,44	0,6	3,2	14	450
DP 81 T	3x230-400 V -	0,66	0,44	0,6	2,6-1,5	-	-

MODEL	ELECTRICAL DATA						
	VOLTAGE 50 Hz	P1 MAX kW	P2 NOMINAL		In A	CAPACITOR	
			kW	HP		µF	Vc
DP 100 M	1x220-240 V -	0,79	0,75	1	3,8	16	450
DP 100 T	3x230-400 V -	0,74	0,75	1	2,6-1,5	-	-

Warning:

Pumps must not operate below their minimum "Delivery Pressure" as shown in the accompanying charts, as pumps will cavitate (loss of prime, air in water, fluctuating pressure gauge and extra pump noise are indications of cavitation), causing damage to pump components including bearings.
 E.g.1. DP81 pump with E25 Ejector Type at Suction Depth of 9 m must not operate with a delivery pressure below 1.5 bar. E.g.2. DP100 pump with E30 Ejector Type at Suction Depth of 21 m must not operate with a delivery pressure below 2.0 bar. If cavitation persists, delivery pressure may need to be raised, as suction depth may be lower than expected.

DP 151 – 251

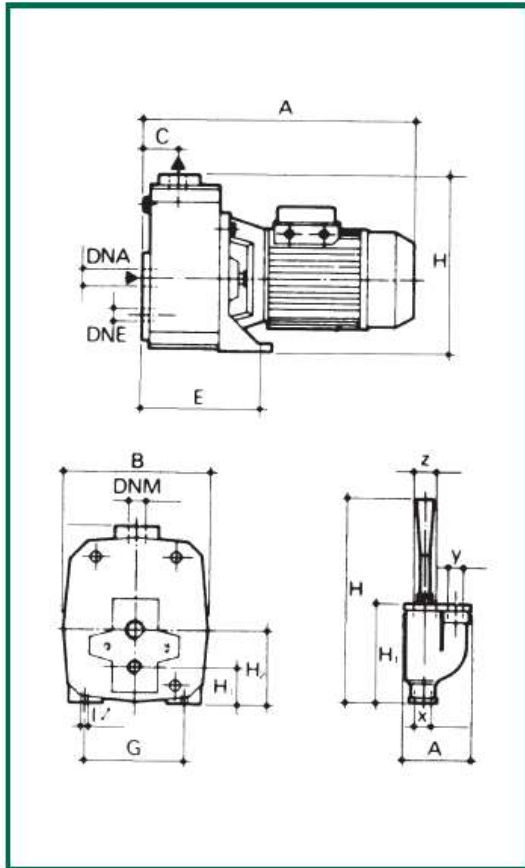

HYDRAULIC DATA (n = 2800 1/min)											
PUMP TYPE	EJECTOR TYPE	SUCTION DEPTH	Delivery pressure in bar								
			3	3,5	4	4,5	5	5,5	6	6,5	7
			Capacity table in l/h								
DP 151	E 20	9	3470	2890	2220	1500	750	-	-	-	-
		12	3110	2510	1850	1100	300	-	-	-	-
		15	2710	2100	1380	640	-	-	-	-	-
		18	2360	1700	950	-	-	-	-	-	-
	E 25	15	2800	2330	1830	1350	900	520	-	-	-
		18	2530	2050	1550	1090	680	300	-	-	-
		21	2280	1800	1300	860	470	-	-	-	-
	E 30	21	1820	1650	1410	1180	910	700	520	-	-
		24	1680	1520	1260	1020	780	580	420	-	-
27		1550	1360	1110	890	680	490	330	-	-	
DP 251	E 20	9	4300	3600	2900	2180	1400	640	-	-	-
		12	3750	3140	2540	1700	940	-	-	-	-
		15	-	2780	2040	1300	500	-	-	-	-
		18	-	2340	1610	820	-	-	-	-	-
	E 25	15	-	2920	2400	1900	1400	950	570	-	-
		18	-	2600	2110	1620	1150	720	360	-	-
		21	-	2350	1850	1350	900	510	-	-	-
		24	-	2050	1550	1080	660	300	-	-	-
	E 30	21	-	-	1710	1480	1220	980	770	590	420
24		-	-	1580	1330	1080	850	670	490	330	
27		-	-	1440	1200	950	750	560	400	250	

MODEL	A	B	C	E	G	IØ	H	H1	H2	DNA	DNM	DNE	EIETTORE						PACKING DIMENSIONS			VOL. m³	WEIGHT Kg
													A	H	H1	x	y	z	L/A	L/B	H		
DP 151	388	210	50	197	145	11	255	53	108	1 1/4" G	1" G	1" G	97	295	143	1" G	1" G	1 1/4" G	427	246	307	0,3	28,5
DP 251 M	462	210	50	197	145	11	255	53	108	1 1/4" G	1" G	1" G	97	295	143	1" G	1" G	1 1/4" G	522	246	307	0,4	32,5
DP 251 T	388	210	50	197	145	11	255	53	108	1 1/4" G	1" G	1" G	97	295	143	1" G	1" G	1 1/4" G	427	246	307	0,3	27,9

MODEL	ELECTRICAL DATA						
	VOLTAGE 50 Hz	P1 MAX kW	P2 NOMINAL kW	HP	In A	CAPACITOR µF	Vc
DP 151 M	1x220-240 V -	1,56	1,1	1,5	7	31,5	450
DP 151 T	3x230-400 V -	1,45	1,1	1,5	4,7-2,7	-	-

MODEL	ELECTRICAL DATA						
	VOLTAGE 50 Hz	P1 MAX kW	P2 NOMINAL kW	HP	In A	CAPACITOR µF	Vc
DP 251 M	1x220-240 V -	1,84	1,85	2,5	8,3	40	450
DP 251 T	3x230-400 V -	1,78	1,85	2,5	5,6-3,2	-	-

Warning:

Pumps must not operate below their minimum "Delivery Pressure" as shown in the accompanying charts, as pumps will cavitate (loss of prime, air in water, fluctuating pressure gauge and extra pump noise are indications of cavitation), causing damage to pump components including bearings. E.g.1. DP151 pump with E20 Ejector Type at Suction Depth of 9 m must not operate with a delivery pressure below 3.0 bar. E.g.2. DP251 pump with E30 Ejector Type at Suction Depth of 21 m must not operate with a delivery pressure below 4.0 bar. If cavitation persists, delivery pressure may need to be raised, as suction depth may be lower than expected.

PRELIMINARY CONSIDERATIONS

Location

Pump can be located at the bore or well, or can be offset some distance away from the water source. For best performance, the pump should be located as close as possible to the water source.

Ventilation, cover and drainage must be provided to prevent damage from moisture to the motor and switches if fitted. The pump must be firmly anchored and pipe work supported.

The pump and all piping must be protected from freezing, and pump and piping drained when not in use if there is a danger of freezing.

Bore Conditions

New bores should be pumped clean of all sand and foreign matter before installing the pump to prevent damage to the pumping system.

The non-return valve should be installed a minimum of 2 metres from the bottom of the bore to prevent sand, mud and other foreign matter from entering the pumping system.

The well must be capable of supplying a sufficient quantity of water to satisfy the demands of the pump. The water level must draw down below the maximum rated depth of the pump, or loss of capacity and prime as well as damage to the pump will occur.

Piping

Old or badly scaled pipe should not be used as dislodged flakes of scale can disrupt the operation of the injector assembly and cause pumping malfunction.

Use only pipe in good condition, free of rust or scale. Threads should be sharp and clean and tightened to manufacturers' specifications.

All threaded joints should be sealed appropriately either by Teflon tape or approved sealant.

Note: The entire system must be air and water tight for efficient operation.

Type of Pipe

Plastic or galvanised steel pipe may be used in the installation of jet pumps.

Rural Compression fittings are supplied in the Injector Kit.

Water to Pump Piping

All offset piping should slope upwards from water source to pump.

Avoid dips or pockets in offset piping, or air will accumulate at high points and make priming difficult.

Install unions at pump and at bore head to aid in servicing.

Allow enough room around pump and piping installation to allow the use of wrenches, installation and servicing.

Do not use piping of sizes smaller than those listed in Chart 1, or pump will not operate correctly.

**Chart 1
Pipe Sizes Required between Water Source and Pump**

Distance: Water to Pump	DP81		DP100		DP151		DP251	
	Suction Pressure		Suction Pressure		Suction Pressure		Suction Pressure	
0-30m	32 mm	25 mm	32 mm	25 mm	32 mm	25 mm	32 mm	25 mm
30-100m	40 mm	32 mm	40 mm	32 mm	40 mm	32 mm	40 mm	32 mm
100-200m	50 mm	40 mm	50 mm	40 mm	50 mm	40 mm	50 mm	40 mm
Over 200m	50 mm	50 mm	50 mm	50 mm	50 mm	50 mm	50 mm	50 mm

Offset Application Friction Loss.

Friction loss in pipe work between water source and pump in offset applications needs to be calculated and added to depth to water to provide an “apparent” depth to water figure, so that the correct injector kit can be specified. As a general rule for DAB pumps, 50mm suction and 40mm pressure (drive) pipes should be used, and as such, the friction loss figure in metres approximates 6% of the distance to the water source.

Example: DP151M pump
10m depth to water.
200m distance to water source from pump, using 50mm suction and 40mm pressure (drive) pipes.

Apparent depth to water = 10m + 6% of 200m (12m) = 22m. Use E30 (page 4)

INSTALLATION

Injector Kit

Check that the injector kit (if supplied) is complete, and that it is the correct version for your application (note: performance charts pages 3 and 4). E20, E25 and E30 kits are identical with the exception of the venturi, which has its identification number moulded into the hex section.

Parts List

DESCRIPTION	QTY
INJECTOR BODY	1
VENTURI E20, E25 or E30	1
BRASS NIPPLE 1"	1
POLY PIPE PIECE 1"x1"x320mm	1
POLY PIPE PIECE 1-1/4"x1-1/4"x200mm	1
END CONNECTOR POLY x FI 1" x 1"	1
END CONNECTOR POLY x FI 1-1/4" x 1-1/4"	1
GATE VALVE 1"	1
PLUG 1"	1
GALVANISED PIPE 1"x1"x100mm	1
GALVANISED PIPE 1-1/4"x1-1/4"x200mm	1
POLY ELBOW 1"	1
POLY ELBOW 1-1/4"	1
THREAD TAPE	1
NON RETURN VALVE 1"	1
STRAINER 1"	1

Note: Illustrated parts list at end of this manual.

Injector Kit Assembly

All threaded joints should be sealed appropriately either by Teflon tape or approved sealant.

Note: The entire system must be air and water tight for efficient operation.

Screw venturi into injector body.



Assemble poly pipe pieces and poly end connectors onto injector body,



Assemble galvanised pipe pieces and poly elbows.



Assemble galvanised pipe pieces with poly elbows onto pump. Assemble nipple and gate valve onto pump discharge.

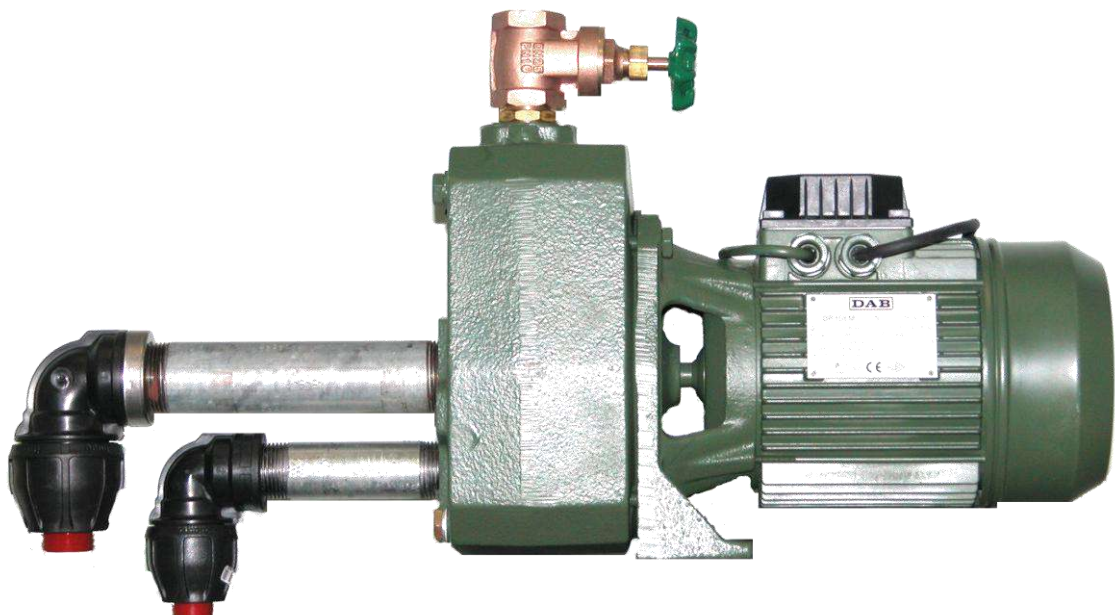

Water to Pump Piping

For pipe size recommendations refer to Chart 1 on page 6.

Always seal pipe ends during installation to stop debris entering the drive and suction pipes, as blockages in the injector body and jet will seriously affect performance.

Add sufficient pressure (drive) pipe and suction pipe to submerge the injector 3 to 5 metres below the pumping water level, making certain that the non-return valve plus strainer (foot valve) are at least 2 metres from the bottom of the bore.

Check pipes and foot valve for leaks by filling pipes with water. A continuous loss of water indicates a leak in the piping, foot valve or unions and must be corrected.

If no leaks are found, connect pressure and suction pipes from bore to pump.

Unions in suction and pressure piping near pump and bore will aid in servicing. Leave enough surrounding room so that wrenches can be used easily.

If larger than standard diameter pipe is to be connected to the injector assembly, the use of 2 m to 3m 25 mm and 32 mm risers is suggested so that there is sufficient length to accommodate the pipe deflection (without damage) required to fit the larger poly end connector/adaptors.

General

Fluids

The pump has been designed and built for pumping water, free from explosive substances and solid particles and fibres, with a density of 1000 kg/m^3 and a kinematic viscosity of $1 \text{ mm}^2/\text{s}$, and chemically non-aggressive liquids and having temperature range within $0 - + 40^\circ\text{C}$.

Electrical Connection

Caution! Always follow the safety regulations.

Scrupulously follow the wiring diagrams inside the terminal board box.

A skilled and licensed electrician must carry out the electrical installation.

Ensure that the voltage is the same as the value shown on the motor plate and there is the possibility of making a good earth connection.

In fixed installations, international Safety standards require the use of isolating switches with a fuse carrier base.

Single-phase motors are provided with built-in thermal overload protection and may be connected directly to the mains. Three phase motors must be protected with an automatic switch (e.g. circuit breaker) calibrated to the value shown on the data plate of the motor.

Line fuses:

	Model	240V 1ph	415V 3ph
Fuse size (Amps)	DP81	4	2
Fuse size (Amps)	DP100	6	4
Fuse size (Amps)	DP151	10	4
Fuse size (Amps)	DP251	16	6

START UP

Check motor shaft rotation. Before power is connected and pump started, it must be checked that the rotating parts turn freely. For this purpose remove the fan cover from its seat in the motor end cover. Insert a screwdriver in the notch on the motor shaft from the ventilation side. If there is a blockage, turn the screwdriver, tapping it gently with a hammer. Replace the fan cover, and check free rotation again to ensure that the fan cover does not come in contact with the fan.

Before starting up, check that the pump is properly primed. Fill the pump and the pipes leading to the water source fully with clean water by means of the hole provided after removal of the filling plug on the pump body. This ensures that the mechanical seal is well lubricated and that the pump immediately starts to work. Dry operation causes irreparable damage to the mechanical seal. The filling plug must then be screwed back on carefully.

On deep well installations, all air must be vented from the pressure (drive) and suction pipes as well as the pump body before the pump will prime. It may be necessary to fill the pump body several times to achieve prime.

DEEP WELL START UP

Ensure pump and pipe work are completely primed.

In some offset applications, forced priming may be necessary from the water source using an engine powered pump. Install a pipe tee in the drive or pressure pipe with a gate valve as close to the water source as possible. Whilst priming, start the engine driven pump and deep well pump together and run until all air is expelled. Reduce speed on the engine driven pump gradually whilst maintaining minimum drive pressure at the deep well pump by adjusting the gate valve. Close the suction gate valve once the pump maintains pressure. Seal off inline tee, as it may be needed in the future.

The injector kit (if supplied) is provided with a control (gate) valve. Its purpose is to provide the back-pressure on the pump required to divert some of the pumped flow down the drive (pressure) pipe to give energy to the injector assembly to raise water up the suction pipe from depths.

See Pages 3 and 4 for minimum delivery pressures.

Ensure that the control valve (gate valve) is fitted to the pump discharge and that it is fully closed (handle turned completely clockwise), then start the pump. If using a priming tee on the discharge, make sure the control valve is closed and pressure tank connected prior to start up.

If fitted with a pressure switch, adjust the cutout pressure to maximum so that the pump does not cut out whilst adjusting the injector drive pressure.

If the pump is properly primed, pressure will build quickly and register on the pressure gauge (if fitted). If not supplied with the pump, it is highly recommended that a pressure gauge be fitted to the pump body by removing the plug provided for this purpose. If pressure does not build, repeat the priming operation. Avoid running the pump against a closed discharge for more than a short time. **To do so can boil the water in the pump causing hazardous pressures, risk of explosion, scalding and pump damage.**

Pump will not prime if there is any leakage in the “suction” piping.

With the pump operating at high pressure, and all expected demands available, (for example two taps open, or solenoid valve opened to four sprinklers, etc) slowly open the control (gate) valve by turning the handle counter clockwise until the pressure gauge (if fitted) or water stream starts to flutter. Close the valve just enough to stop the flutter. Maximum flow is now obtained. The pump pressure at this point should be the same or above that shown in the chart.

If fitted with a pressure switch, adjust to the required pressures. Cut in pressure must not be lower than the minimum drive pressure.

If the control valve is opened too far, pump damaging cavitation will occur, and will be noticeable by cavitation noise and pressure fluctuations. Opening the valve further will cause the pump to lose prime.

When satisfied that the pump is operating correctly, remove the handle of the control valve and store it in a safe place to avoid tampering of the pump unit.



TROUBLESHOOTING

FAULT	CHECKS (possible cause)	REMEDY
1. The motor does not start and makes no noise.	<p>A. Check the electric connections.</p> <p>B. Check the motor is live.</p> <p>C. Check the protection fuses.</p> <p>D. Check the pressure switch is live.</p> <p>E. Ensure that the pressure tank pre-charge pressure is not higher than the cut in pressure of the pressure switch.</p>	<p>C. If they are burnt out, change them. N.B. If the fault is repeated immediately, this means that the motor is short cycling.</p> <p>E. Set the precharge pressure 3 psi (0.2 bar) below the cut in pressure of the switch.</p>
2. The motor does not start but makes noise.	<p>A. Ensure that the mains voltage is the same as the value on the name plate.</p> <p>B. Ensure the connections have been made correctly.</p> <p>C. Check that all the phases are present on the terminal board (3ph).</p> <p>D. Look for possible blockages in the pump or motor.</p> <p>E. Check the condition of the capacitor.</p>	<p>B. Correct any errors.</p> <p>C. If not, restore the missing phase.</p> <p>D. Remove the blockage.</p> <p>E. Replace the capacitor.</p>
3. The motor turns with difficulty.	<p>A. Check the voltage which may be insufficient.</p> <p>B. Check whether any moving parts are fouling against fixed parts.</p>	<p>B. Eliminate the cause of the fouling.</p>
4. The pump does not deliver.	<p>A. The pump has not been primed properly.</p> <p>B. The diameter of the intake pipe is insufficient.</p> <p>C. Blocked foot valve or injector assembly.</p>	<p>B. Replace the pipe with one of a larger diameter.</p> <p>C. Clean the foot valve and injector assembly.</p>
5. The pump does not prime.	<p>A. The intake pipe or footvalve is taking in air.</p> <p>B. The downward slope of the intake pipe favours the formation of air pockets.</p>	<p>A. Correct the problem and prime again.</p> <p>B. Correct the inclination of the intake pipe.</p>
6. The pump supplies insufficient flow.	<p>A. Blocked foot valve or injector assembly.</p> <p>B. The impeller is worn or blocked.</p> <p>C. The diameter of the intake pipe is insufficient.</p>	<p>A. Clean the foot valve and injector assembly.</p> <p>B. Remove the obstruction or replace the worn parts.</p> <p>C. Replace the pipe with one of a larger diameter.</p>
7. The pump vibrates and operates noisily.	<p>A. Check that the pump and the pipes are firmly anchored.</p> <p>B. There is cavitation in the pump.</p> <p>C. The pump is running above its performance characteristics.</p>	<p>A. Fix the loose parts.</p> <p>B. Reduce the intake height or check for friction losses.</p> <p>C. Limit the flow by increasing the back pressure.</p>
8. The motor does not stop when the demand for water has ceased.	<p>A. Ensure that the value at which the pressure switch is set to stop the motor is not higher than the pump can generate (suction + delivery).</p> <p>B. Check the the pressure switch contacts move freely.</p>	<p>A. Set the pressure switch at a lower level.</p> <p>B. If faulty, change the pressure switch.</p>
9. The pump starts and stops frequently during normal water delivery.	<p>A. Check that the cut out pressure is not set too low.</p> <p>B. Check that there is correct air pressure in the pressure tank..</p>	<p>A. Increase the cut out pressure ensuring that the pump will turn off. Do not forget to then check the cut in pressure.</p> <p>B. Set the precharge pressure 3 psi (0.2 bar) below the cut in pressure of the switch.</p>